



WALKER

Ficha técnica
Datasheet
Ficha técnica
Fiche technique

COMPONENTES

components/ componentes/ composants



- A** Estrutura interior em madeira revestida a espuma de poliuretano flexível com densidades entre 20 e 26 AZ / AM kg/m³ SUPRA_CELL basic.
Wooden inner frame covered in flexible polyurethane foam with densities between 20 and 26 AZ/AM kg / m_ SUPRA_CELL basic
Estructura interior en madera, cubierta con espuma de poliuretano flexible con densidades entre 20 e 26 AZ / AM kg/m³ SUPRA_CELL basic..
Structure à l'intérieur en bois, enduit de mousse de polyuréthane flexible avec des densités entre 20 and 26 AZ / AM Kg/m³ SUPRA_CELL basic.

- A₁** Costa opcional.
Optional backrest.
Costa opcional.
Côte optionnelle.



- B** Pé em tubo de metalico com Ø16mm, cromado ou pintado em branco ou preto.
Ø16mm metallic tube legs, chrome finish or painted in white or black.
 Pies en tubo metálico de Ø16mm, cromado o pintado en blanco o negro.
Pietment en tube métallique de Ø16mm, chromé ou peint en blanc ou noir.

- C** Componentes anti-derrapante e anti-riscos.
Anti-skid and scratch protection pads.
 Componentes antideslizantes y antiarañazos
Composants antidérapants et anti-rayures.

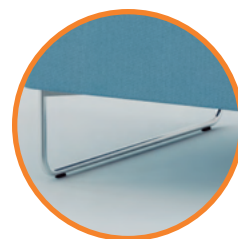

- D₁** Bases conectoras em MDF revestidos a folha de madeira ou melamina.
MDF connector bases coated with melamine or wood sheet.
 Bases conectivas de MDF recubiertas de madera o melamina.
Bases de connexion en MDF revêtues de bois dur ou mélaminé.



- D₂** Modulo central e mesa de centro estofados com tampo de madeira embutido revestido a melamina.
Upholstered central module and coffee table with a wood built-in top, covered with melamine.
 Módulo central y mesa de centro tapizado con tapa de madera con incrustaciones de melamina.
Module central et table basse rembourrés avec dessus en bois incrusté de mélamine.



- D₃** Opção de eletrificação com tomada e USB (Ø70mm).
Optional electrification with socket and USB (Ø70mm).
 Opción de electrificación con enchufe y USB (Ø70mm).
Option d'électrification avec prise et USB (Ø70mm).



.....
 710

- D₄** Componentes anti-derrapante e anti-riscos.
Anti-skid and scratch protection pads.
 Componentes antideslizantes y antiarañazos.
Composants antidérapants et anti-rayures.



VERSÕES E DIMENSÕES

dimensions and versions/ versiones y dimensiones / versions et dimensions

Medidas em milímetros.
Measurements in millimeters.
Medidas en milímetros.
Mesures en millimètres.



Pouf individual
Individual pouf
Pouf individual
Pouf individuel

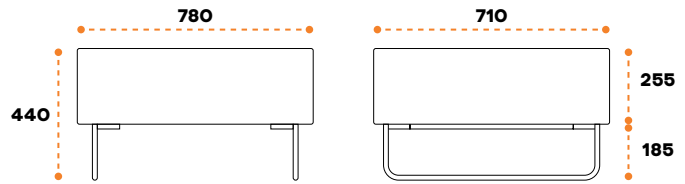

NEXUS A

16 Kg . 0.19 m³



Sofá individual - Costa ao centro
Single sofa - Central Backrest
Sofá individual - Respaldo central
Canapé individuel - Retour au centre

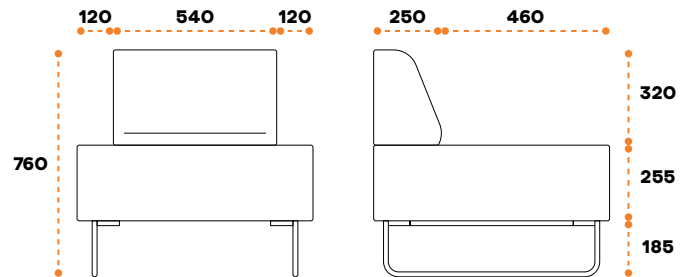

NEXUS B

24 Kg . 0.37 m³



Sofá individual - Costa à esquerda
Single sofa - Left backrest
Sofá individual - Dorso izquierdo
Canapé individuel - Arrière gauche

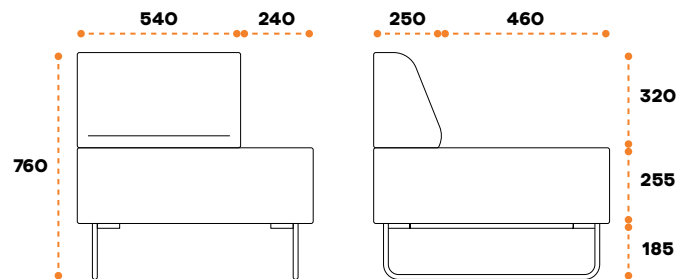

NEXUS C

24 Kg . 0.37 m³



Sofá individual - Costa à direita
Single sofa - Right backrest
Sofá individual - Dorso derecho
Canapé individuel - Dos droit

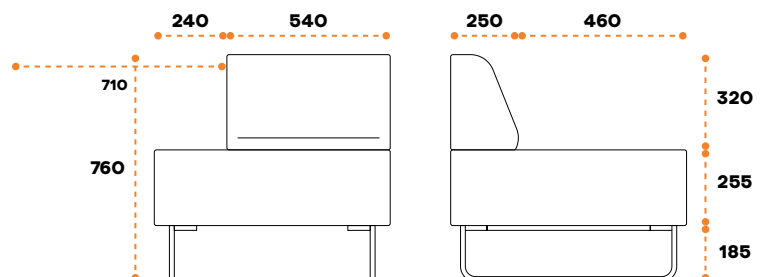

NEXUS D

24 Kg . 0.37 m³

VERSÕES E DIMENSÕES

dimensions and versions/ versiones y dimensiones / versions et dimensions

Medidas em milímetros.
Measurements in millimeters.
Medidas en milímetros.
Mesures en millimètres.

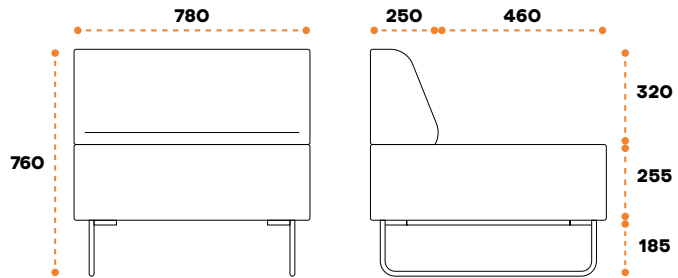

Sofá individual - Costa completa

Individual sofa - Full backrest
Sofá individual - respaldo completo
Canapé individuel - Dossier complet

NEXUS E

25 Kg . 0.37 m³

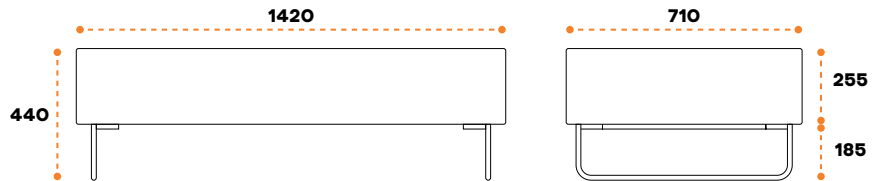

Pouf duplo

Double pouf
Doble pouf
Double pouf

NEXUS F

29 Kg . 0.35 m³

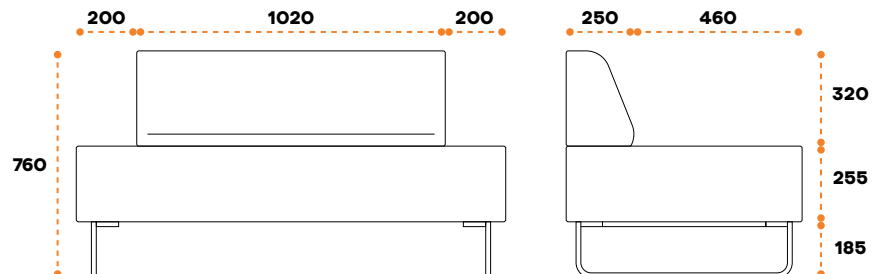

Sofá duplo - Costa ao centro

Double sofa - Central backrest
Sofá doble - Respaldo central
Double canapé - Retour au centre

NEXUS G

38 Kg . 0.68 m³

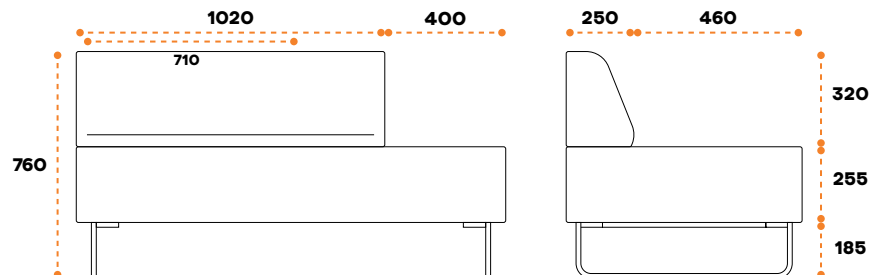

Sofá duplo - Costa à esquerda

Double sofa - Left backrest
Sofá doble - Dorso izquierdo
Double canapé - Arrière gauche

NEXUS H

38 Kg . 0.68 m³

VERSÕES E DIMENSÕES

dimensions and versions/ versiones y dimensiones / versions et dimensions

Medidas em milímetros.
Measurements in millimeters.
Medidas en milímetros.
Mesures en millimètres.

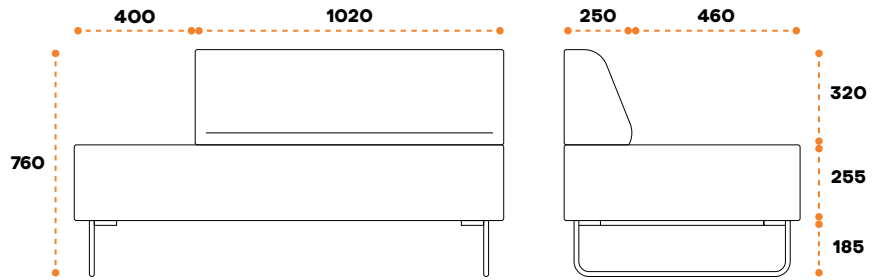

Sofá duplo - Costa à direita

Double sofa - Right backrest
Sofá doble - Dorso derecho
Double canapé - Dos droit

NEXUS I

38 Kg . 0.68 m³

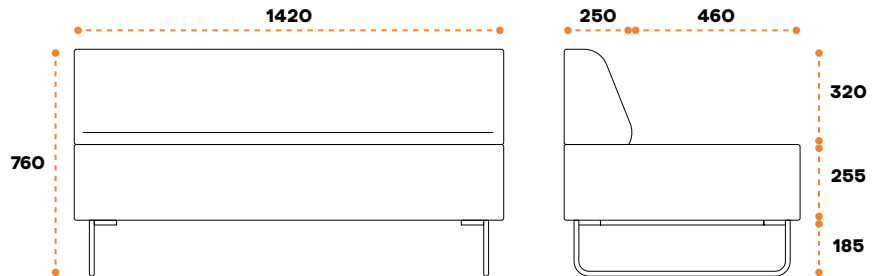

Sofá duplo - Costa completa

Double sofa - Full backrest
Sofá doble - respaldo completo
Double canapé - Dossier complet

NEXUS J

39 Kg . 0.68 m³



Pouf triplo

Triple pouf
Pouf triple
Triple pouf

NEXUS K

42 Kg . 0.48 m³

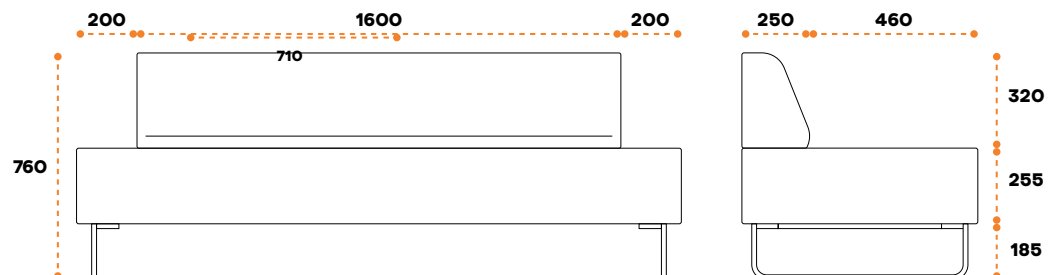

Sofá triplo - Costa ao centro

Triple sofa - Central backrest
Sofá triple - Respaldo central
Canapé triple - Retour au centre

NEXUS L

50 Kg . 0.92 m³

VERSÕES E DIMENSÕES

dimensions and versions/ versiones y dimensiones / versions et dimensions

Medidas em milímetros.
Measurements in millimeters.
Medidas en milímetros.
Mesures en millimètres.

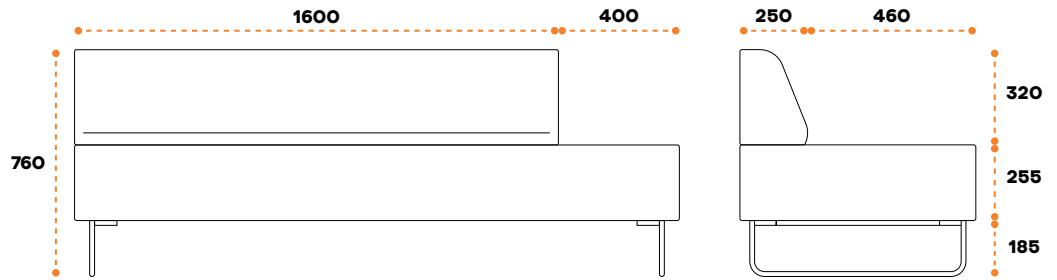

Sofá triplo - Costa à esquerda
Triple sofa - Left backrest
Sofá triple - Dorso izquierdo
Canapé triple - Arrière gauche

NEXUS M

50 Kg . 0.92 m³

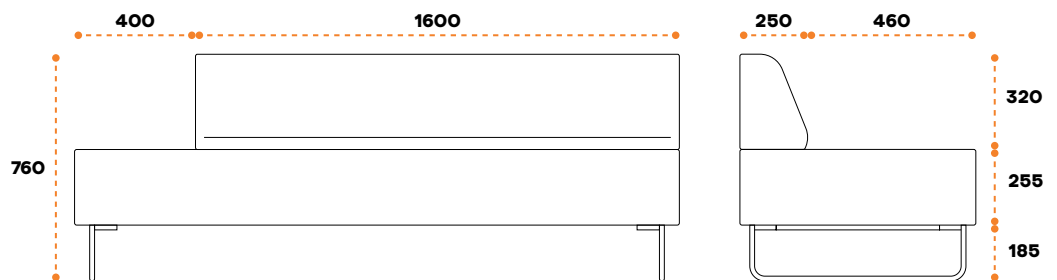

Sofá triplo - Costa à direita
Triple sofa - Right backrest
Sofá triple - Dorso derecho
Canapé triple - Dos droit

NEXUS N

50 Kg . 0.92 m³

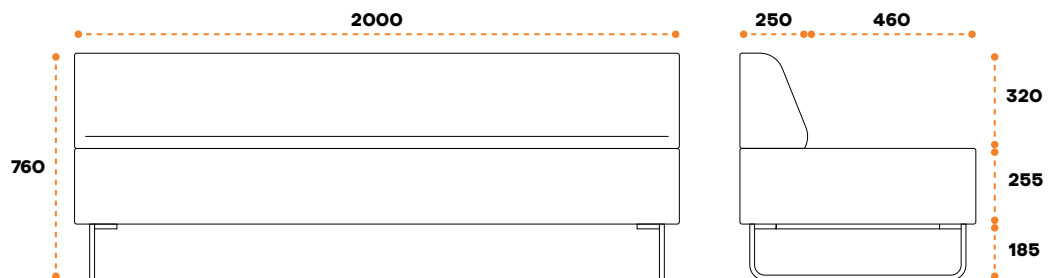

Sofá triplo - Costa completa
Triple sofa - Full backrest
Sofá triple - respaldo completo
Capané triple - Dossier complet

NEXUS O

52 Kg . 0.92 m³

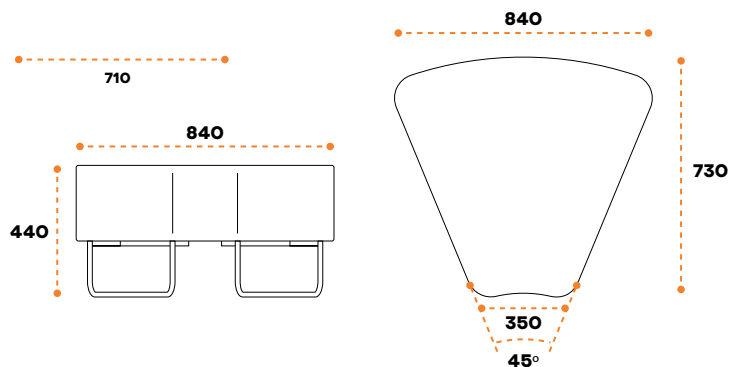

Pouf 45°
45° Pouf
Pouf 45°
Pouf 45°

NEXUS P

16 Kg . 0.22 m³

VERSÕES E DIMENSÕES

dimensions and versions/ versiones y dimensiones / versions et dimensions

Medidas em milímetros.
Measurements in millimeters.
Mesures en millimètres.



Sofá 45°
45° Sofa
Sofá 45°
Canapé 45°

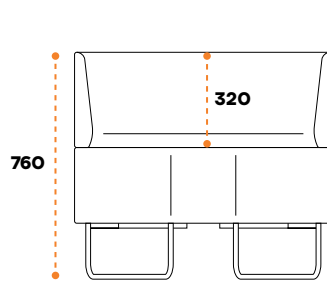

NEXUS Q

35 Kg . 0.43 m³

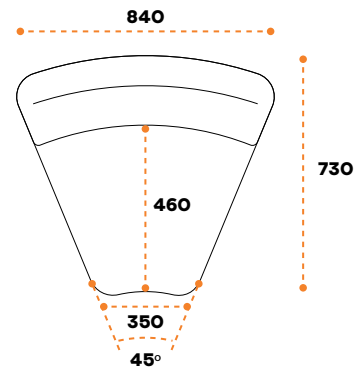

Sofá 45° - Invertido
45° Sofa - Inverted
Sofá 45° - Invertido
Capané 45° - Inversé

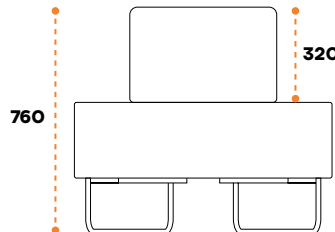

NEXUS R

35 Kg . 0.43 m³

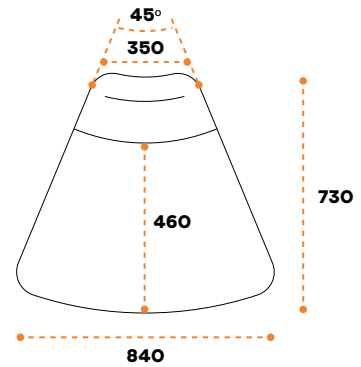

Módulo Central
Center module
Módulo central
Module de centre

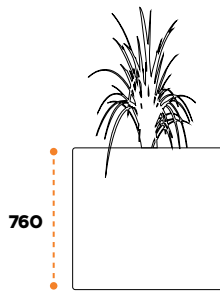

NEXUS S

27 Kg . 0.68 m³

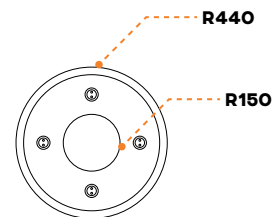

Mesa de centro
Coffe table
Mesa de centro
Table basse

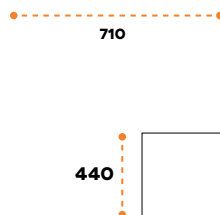

NEXUS T

19 Kg . 0.28 m³

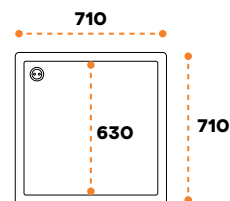

VERSÕES E DIMENSÕES

dimensions and versions/ versiones y dimensiones / versions et dimensions

Medidas em milímetros.
Measurements in millimeters.
Medidas en milímetros.
Mesures en millimètres.



Base conectora à direita
Connecting base - right
Base conectora - derecho
Base connecteur - à droite

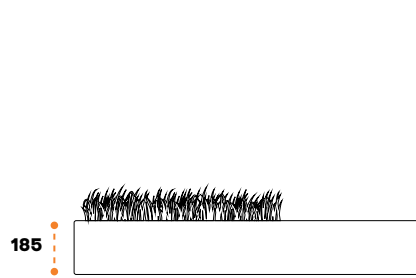

NEXUS U

18 Kg . 0.28 m³

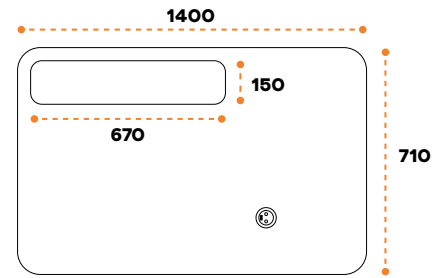

Base conectora
Connecting base
Base conectora
Base connecteur



NEXUS V

18 Kg . 0.28 m³

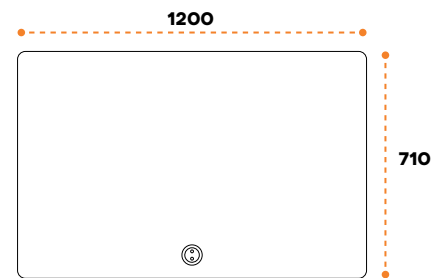

Base conectora - esquerda
Connecting base - left
Base conectora - izquierda
Base connecteur - à gauche

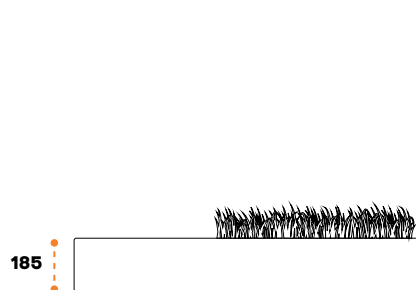

NEXUS W

18 Kg . 0.28 m³

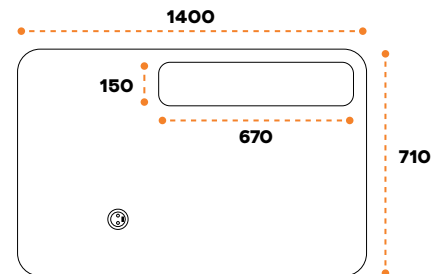

Base conectora 90°
90° Connecting base
Base conectora 90°
Base connecteur 90°

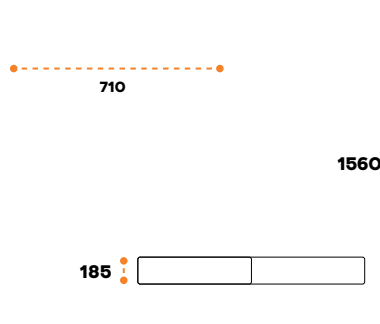

NEXUS Y

18 Kg . 0.28 m³

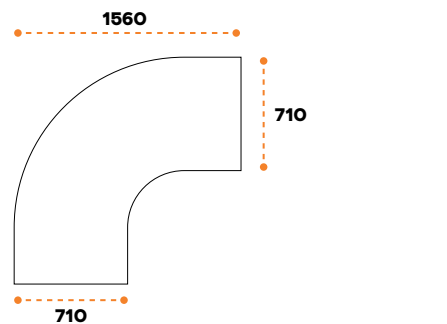

VERSÕES E DIMENSÕES

dimensions and versions/ versiones y dimensiones / versions et dimensions

Medidas em milímetros.
Measurements in millimeters.

Medidas en milímetros.
Mesures en millimètres.



Sofá de canto.

Corner sofa.

Sofá de esquina.

Canapé d'angle.

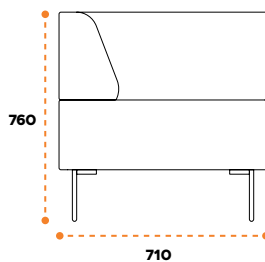

NEXUS X

25 Kg . 0,37 m³

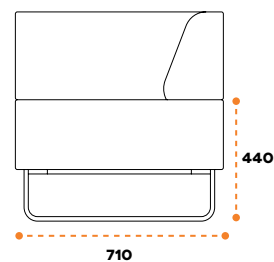

Sofá de canto.

Corner sofa.

Sofá de esquina.

Canapé d'angle.

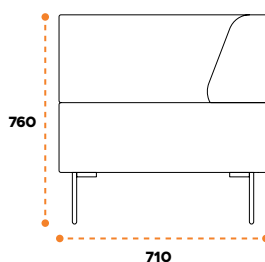

NEXUS Z

25 Kg . 0,37 m³

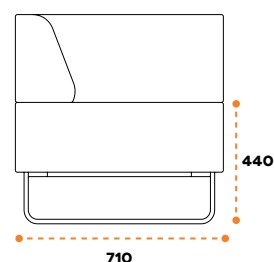

CONFIGURAÇÕES

configuration/ configuraciones/ configuration

Medidas em milímetros.
Measurements in millimeters.
Mesures en millimètres.

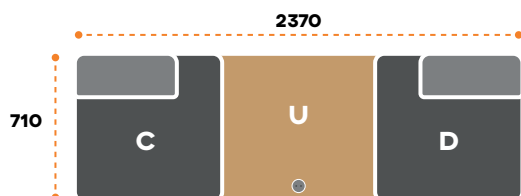
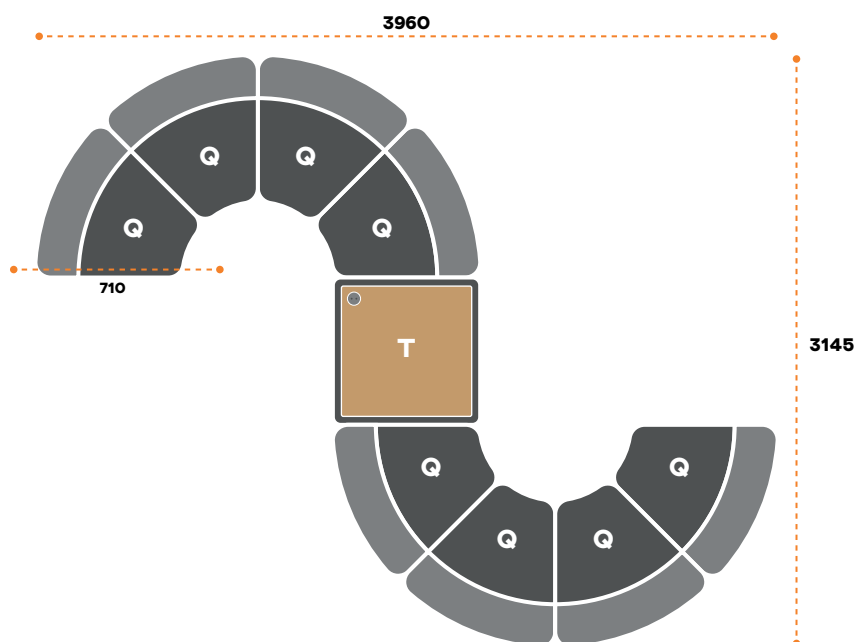
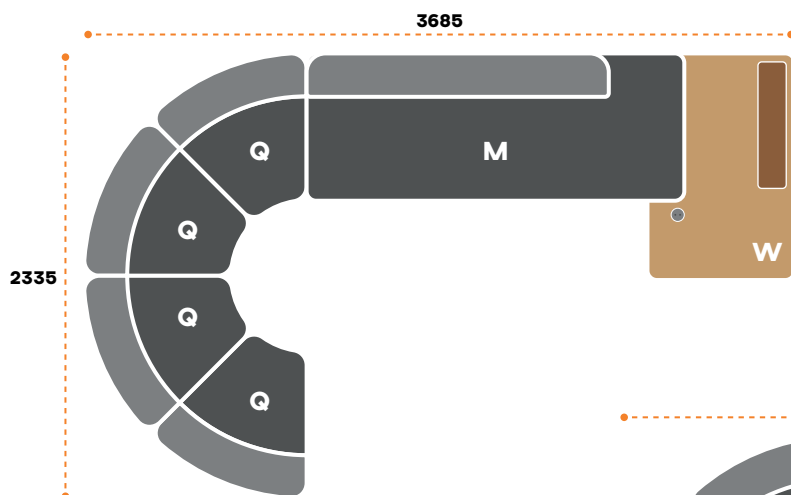
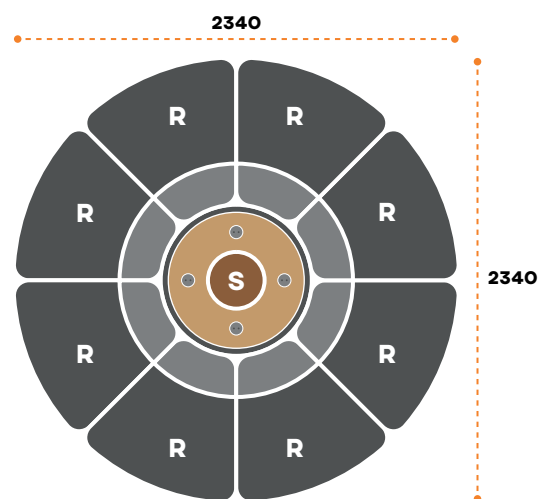
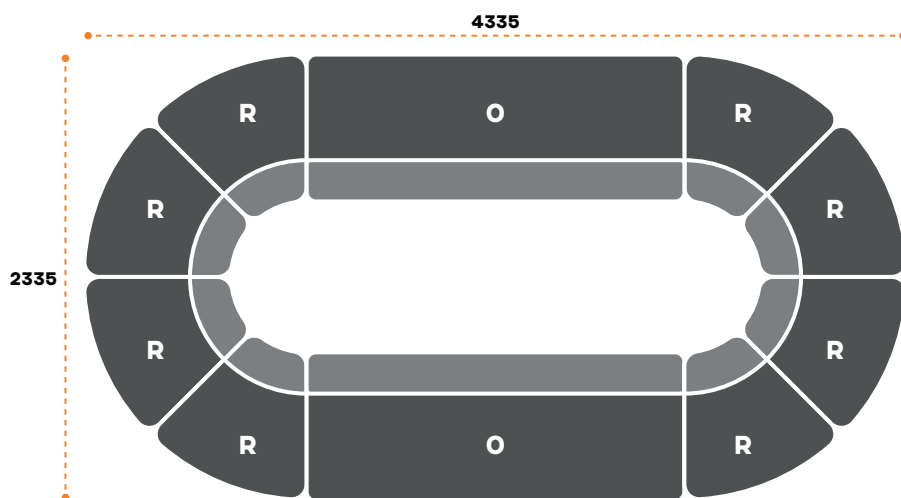

CONFIGURAÇÕES

configuration/ configuraciones/ configuration

Medidas em milímetros.
Measurements in millimeters.
Medidas en milímetros.
Mesures en millimètres.

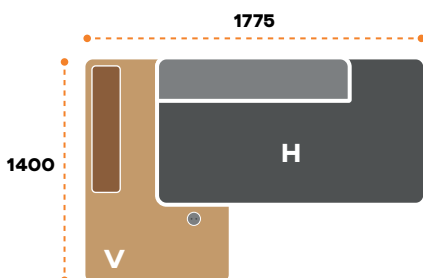
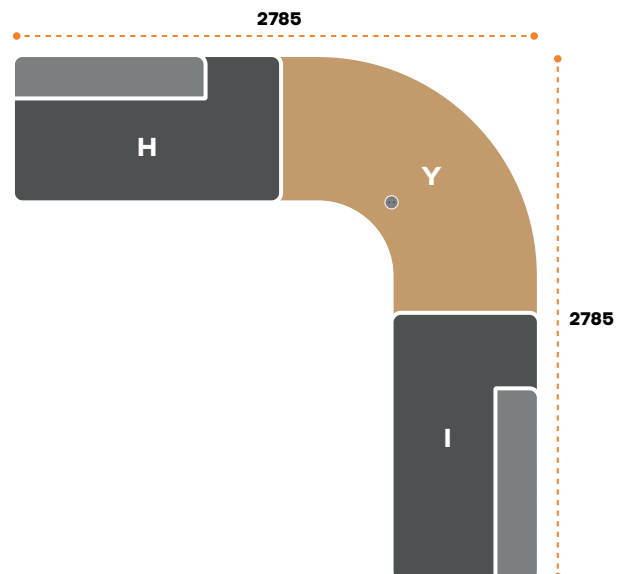
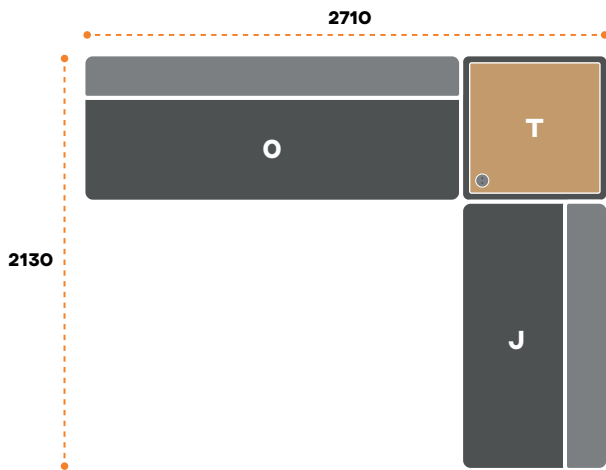
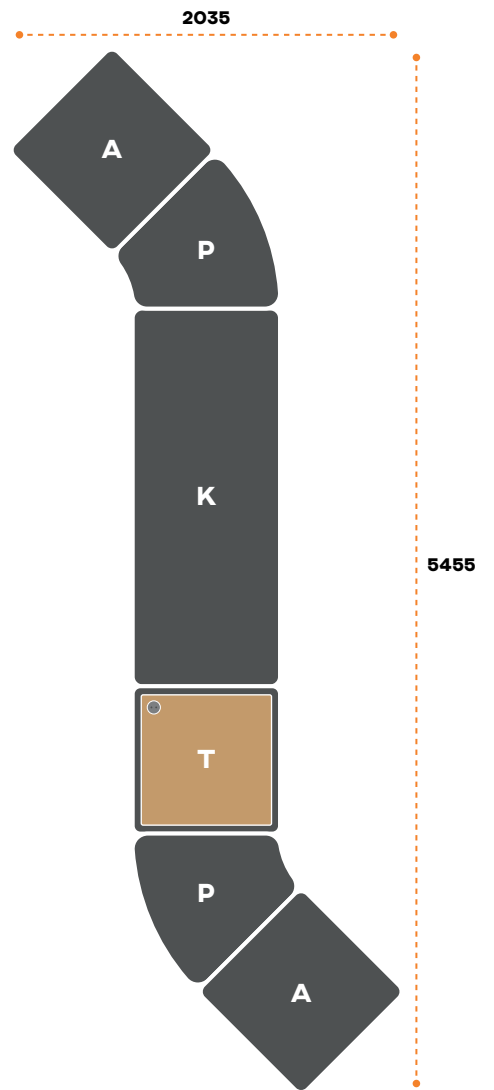
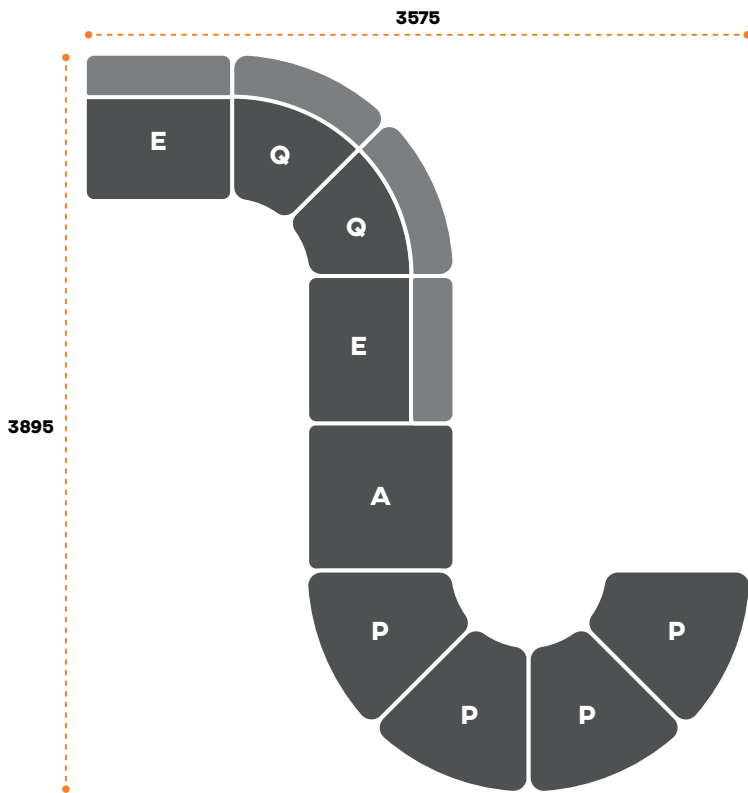

710

CONFIGURAÇÕES

configuration/ configurations/ configuration

Medidas em milímetros.
Measurements in millimeters.
Medidas en milímetros.
Mesures en millimètres.

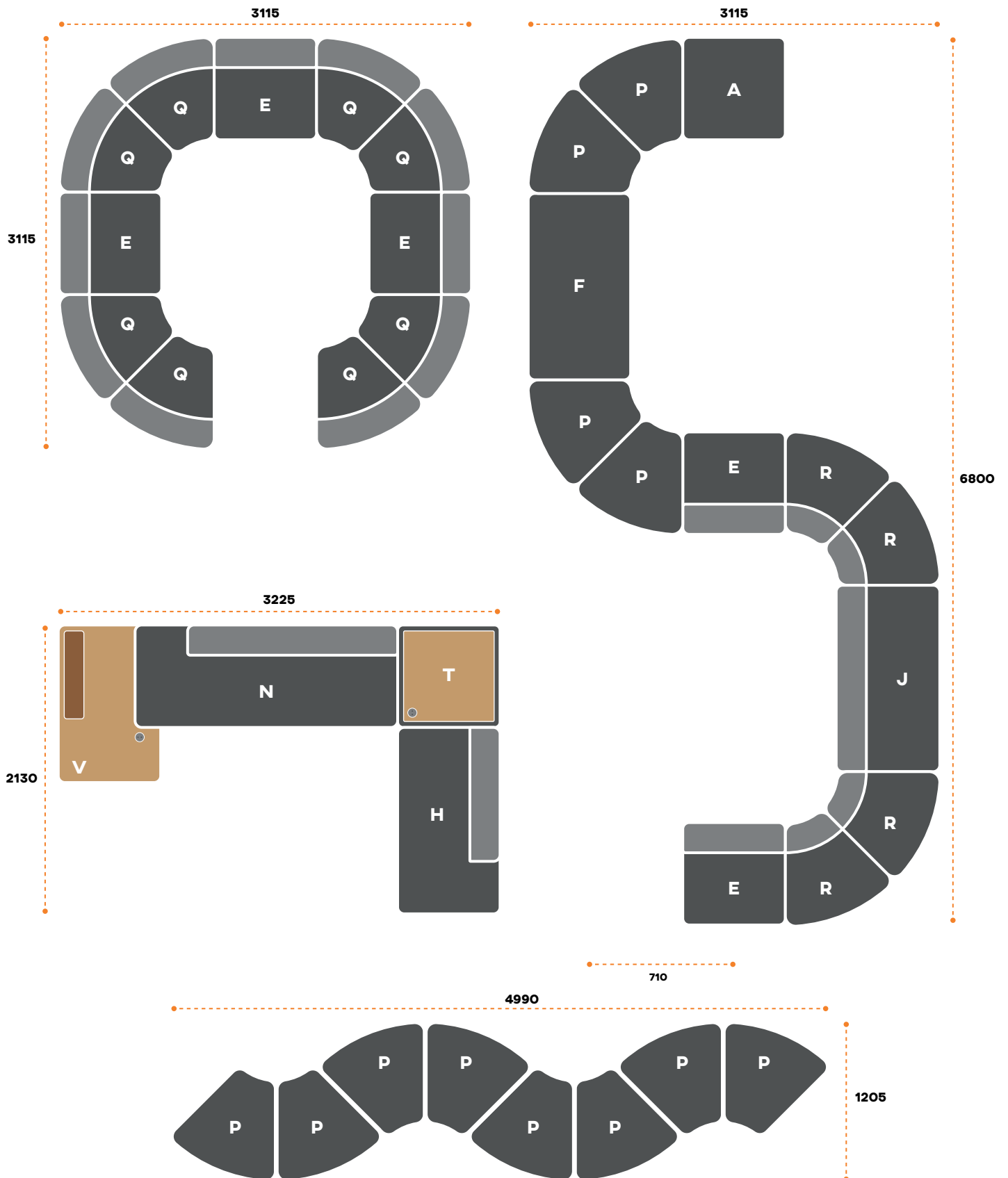



NEW WALKER

Ficha técnica

Datasheet

Ficha técnica

Fiche technique

WALKER TECHNICAL SPECIFICATIONS

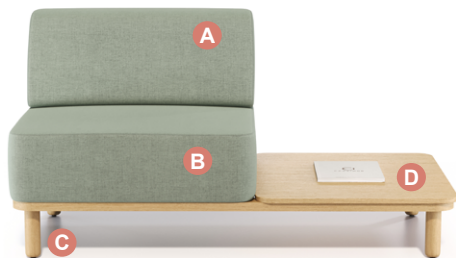

A, B - Costa e assento com estrutura interior em madeira revestida a espuma de poliuretano flexível com densidades entre 20 e 30 AZ / AM kg/m³ SUPRA_CELL basic.

Back and seat with interior structure in wood, coated with flexible polyurethane foam with densities between 20 and 30 kg / m³ SUPRA_CELL basic.

Respaldo y asiento con estructura interior en madera, cubierta con espuma de poliuretano flexible con densidades entre 20 y 30 AZ/AM kg / m³ SUPRA_CELL Basic.

Dossier et siège avec structure à l'intérieur en bois, enduit de mousse de polyuréthane flexible avec des densités entre 20 EBR et 30 BR/PR kg / m³ SUPRA_CELL basic.

C - Pés em madeira maça de faia Ø50mm.

Ø50mm beech wood feet.

Patas de madeira de haya Ø50mm.

Pieds en bois de hêtre Ø50mm.



LEGS OPTIONS

SOLID BEECH WOOD FINISHES

ACABAMENTOS EM MADEIRA MACIÇA DE FAIA / ACABADOS EN MADERA MACIZA DE HAYA / FINITIONS EN BOIS DE HÊTRE MASSIF



D - Mesa de apoio de 19mm espessura.

19mm thick side table.

Mesa auxiliar de 19 mm de espesor.

Table basse de 19 mm d'épaisseur.



TABLE TOP OPTIONS

MELAMINE COLORS

CORES MELAMINA / COLORES MELAMINA / COULEURS MÉLAMINE

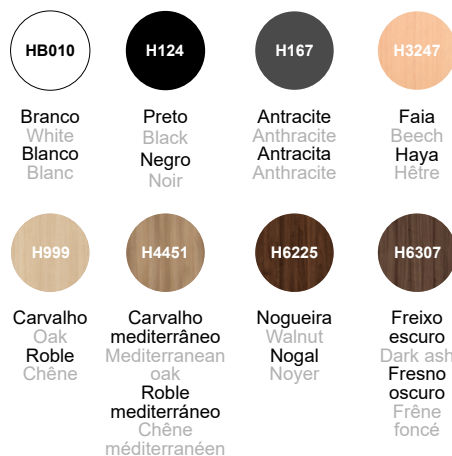

MFC WITH PLYWOOD EFFECT EDGE

MELAMINA COM ORLA A IMITAR CONTRAPLACADO / MELAMINA CON CONTRACHAPADO EFECTO BORDE / MÉLAMINE AVEC CONTREPLAQUÉ

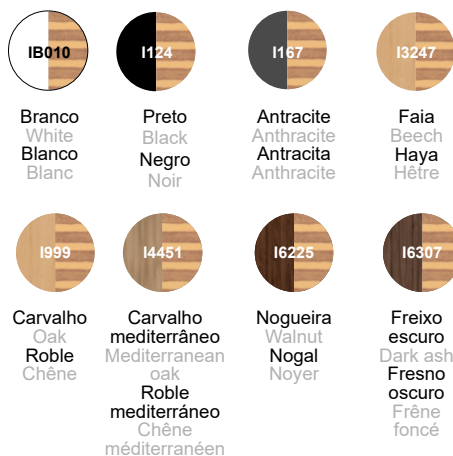

STAIN FINISHES FOR WOOD VENEER

FOLHEADOS DE MADEIRA COM VELATURA / CHAPAS DE MADERA CON VELATURA / PLACAGES DE BOIS AVEC VELATURE



REVESTIMENTOS

COATINGS / REVESTIMIENTOS / REVÊTEMENTS



GARANTIA

WARRANTY / GARANTÍA / GARANTIE

2 anos / 2 years / 2 años / 2 années

WALKER TECHNICAL SPECIFICATIONS

VERSIONS

VERSÕES / VERSIONES / VERSIONS

NEXUS - A1



Pouf individual com mesa de apoio em melamina à esquerda. Pés em madeira de faia.

Individual pouf with melamine coffee table on the left. Beech wood legs.

Pouf individual con mesa de apoyo de melamina a la izquierda. Patas de madera de haya.

Pouf simple avec table basse en mélamine à gauche. Pieds en hêtre.

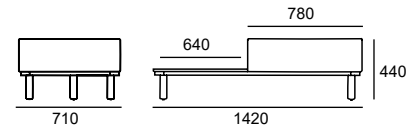

NEXUS - A2



Pouf individual com mesa de apoio em melamina à direita. Pés em madeira de faia.

Individual pouf with melamine coffee table on the right. Beech wood legs.

Pouf individual con mesa de apoyo de melamina a la derecha. Patas de madera de haya.

Pouf simple avec table basse en mélamine à droit. Pieds en hêtre.

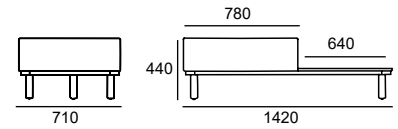

NEXUS - F3



2 poufs individuais com mesa de apoio em melamina ao centro. Pés em madeira de faia.

2 individual poufs with melamine support table in the center. Beech wood legs.

2 poufs individuales con mesa de apoyo de melamina en el centro. Patas de madera de haya.

2 poufs individuels avec table basse en mélamine au centre. Pieds en hêtre.

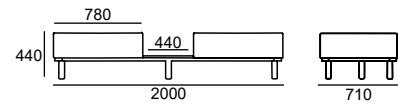

NEXUS - F1



Pouf duplo com mesa de apoio em melamina à esquerda. Pés em madeira de faia.

Double Pouf with melamine support table on the left. Beech wood legs.

Pouf doble con mesa de apoyo de melamina a la izquierda. Patas de madera de haya.

Pouf double avec table basse en mélamine à gauche. Pieds en hêtre.

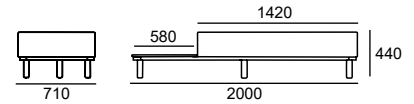

NEXUS - F2



Pouf duplo com mesa de apoio em melamina à direita. Pés em madeira de faia.

Double pouf with melamine support table on the right. Beech wood legs.

Pouf doble con mesa de apoyo de melamina a la derecha. Patas de madera de haya.

Pouf double avec table basse en mélamine à droite. Pieds en hêtre.

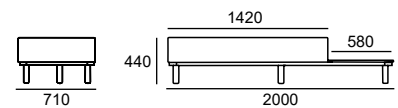

NEXUS - E1



Sofá individual com mesa de apoio em melamina à esquerda. Pés em madeira de faia.

Individual sofa with melamine coffee table on the left. Beech wood legs.

Sofá individual con mesa de apoyo de melamina a la izquierda. Patas de madera de haya.

Canapé simple avec table basse en mélamine à gauche. Pieds en hêtre.

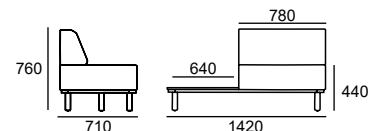

NEXUS - E2



Pouf duplo com mesa de apoio em melamina à esquerda. Pés em madeira de faia.

Double Pouf with melamine support table on the left. Beech wood legs.

Pouf doble con mesa de apoyo de melamina a la izquierda. Patas de madera de haya.

Pouf double avec table basse en mélamine à gauche. Pieds en hêtre.

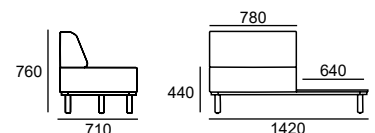

WALKER TECHNICAL SPECIFICATIONS

VERSIONS

VERSÕES / VERSIONES / VERSIONS

NEXUS - J1



Sofá duplo com mesa de apoio em melamina à esquerda. Pés em madeira de faia.

Double sofa with melamine support table on the left. Beech wood legs. Sofá doble con mesa de apoyo de melamina a la izquierda. Patas de madera de haya.

Canapé double avec table basse en mélamine à gauche. Pieds en hêtre.

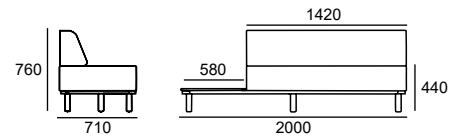

NEXUS - J2



Sofá duplo com mesa de apoio em melamina à direita. Pés em madeira de faia.

Double sofa with melamine support table on the right. Beech wood legs.

Sofá doble con mesa de apoyo de melamina a la derecha. Patas de madera de haya.

Canapé double avec table basse en mélamine à droite. Pieds en hêtre.

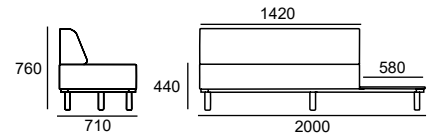

NEXUS - J3



2 sofás individuais com mesa de apoio em melamina ao centro. Pés em madeira de faia.

2 individual sofas with melamine support table on the center. Beech wood legs.

2 sofás individuales con mesa de apoyo de melamina en el centro. Patas de madera de haya.

2 canapés individuels avec table basse en mélamine au centre. Pieds en hêtre.

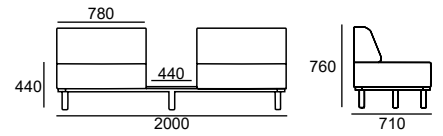

NEXUS - EA1



Sofá individual + pouf individual com mesa de apoio em melamina ao centro. Pés em madeira de faia.

Individual sofa + individual pouf with melamine support table in the center.

Beech wood legs.

Sofá individual + pouf individual con mesa de apoyo de melamina en el centro. Patas de madera de haya.

Canapé simple + pouf simple avec table basse en mélamine au centre. Pieds en hêtre. Canapé simple + pouf simple avec table basse en mélamine au centre. Pieds en hêtre.

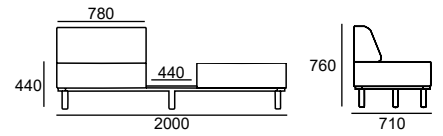

NEXUS - EA2



Sofá individual + pouf individual com mesa de apoio em melamina ao centro. Pés em madeira de faia.

Individual sofa + individual pouf with melamine support table in the center.

Beech wood legs.

Sofá individual + pouf individual con mesa de apoyo de melamina en el centro. Patas de madera de haya.

Canapé simple + pouf simple avec table basse en mélamine au centre. Pieds en hêtre.

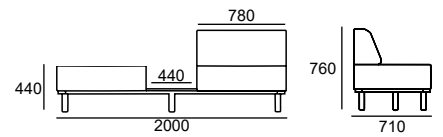



WALKER TABLES

Ficha técnica

Datasheet

Ficha técnica

Fiche technique

WALKER TECHNICAL SPECIFICATIONS (UPGRADE)



A - Tampo de mesa retangular em melamina ou folheado. Rectangular table top in melamine or veneer. Tablero rectangular en melamina o chapado. Plateau rectangulaire en mélamine ou placage.



C - Compartimento para vegetação. Compartment for greenery. Compartimento para la vegetación. Compartiment pour la végétation.



OTHER OPTIONS

OUTRAS OPÇÕES / OTRAS OPCIONES / AUTRES OPTIONS

Tampo de mesa 90° em melamina ou folheado. 90° table top in melamine or veneer. Tablero de 90° en melamina o chapado. Plateau de table 90° en mélamine ou placage.



B - Base estofada. Upholstered base. Base tapizada. Base rembourrée.



TABLE TOP OPTIONS

MELAMINE COLORS

CORES MELAMINA / COLORES MELAMINA / COULEURS MÉLAMINE

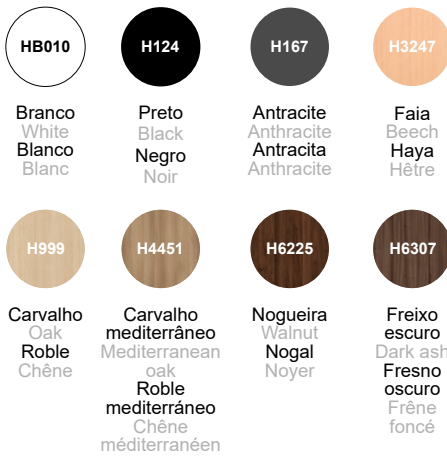

MFC WITH PLYWOOD EFFECT EDGE

MELAMINA COM ORLA A IMITAR CONTRAPLACADO / MELAMINA CON CONTRACHAPADO EFECTO BORDE / MÉLAMINE AVEC CONTREPLAQUÉ

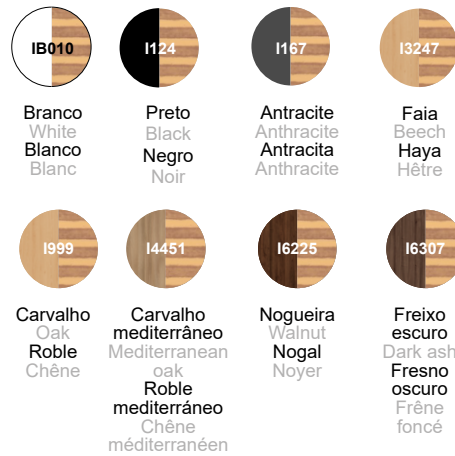

STAIN FINISHES FOR WOOD VENEER

FOLHEADOS DE MADEIRA COM VELATURA / CHAPAS DE MADERA CON VELATURA / PLACAGES DE BOIS AVEC VELATURE



REVESTIMENTOS

COATINGS / REVESTIMIENTOS / REVÊTEMENTS

CAT.1



CAT.2



CAT.3



CAT.4



CAT.5



CAT.6



GARANTIA

WARRANTY / GARANTÍA / GARANTIE

5 anos² / 5 years² / 5 años² / 5 années²

WALKER TECHNICAL SPECIFICATIONS (UPGRADE)

VERSIONS

VERSÕES / VERSIONES / VERSIONS

NEXUS - W



Mesa de apoio esquerda estofada com tampo em melamina, com compartimento para vegetação. Electrificação opcional. Utilização à esquerda.
 Upholstered left-hand side table with melamine top and compartment for greenery. Electrification optional. Use on the left.
 Mesa de apoyo izquierda tapizada con tablero de melamina y compartimento para vegetación. Electrificación opcional. Uso a la izquierda.
 Table latérale gauche rembourrée avec plateau en mélamine et compartiment pour la végétation. Électrification en option. Utilisation à gauche.

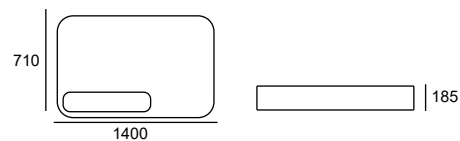

NEXUS - U



Mesa de apoio direita estofada com tampo em melamina, com compartimento para vegetação. Electrificação opcional. Utilização à direita.
 Upholstered right-hand side table with melamine top and compartment for greenery. Electrification optional. Use on the right.
 Mesa de apoyo derecha tapizada con tablero de melamina y compartimento para vegetación. Electrificación opcional. Uso a la derecha.
 Table latérale droite tapissée avec plateau en mélamine et compartiment pour la végétation. Électrification en option. Utilisation à droite.

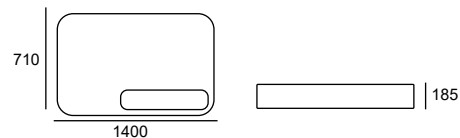

NEXUS - V



Mesa de apoio conectora estofada com tampo em melamina. Electrificação opcional.
 Upholstered connector support table with melamine top. Electrification optional.
 Mesa de apoyo conectora tapizada con tablero de melamina. Electrificación opcional.
 Table de support de connecteur rembourrée avec plateau en mélamine. Electrification en option.

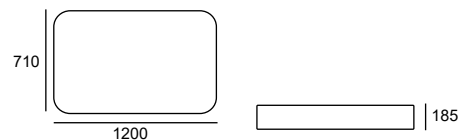

NEXUS - Y



Mesa de apoio conectora a 90° estofada com tampo em melamina. Electrificação opcional.
 Upholstered 90° connector support table with melamine top. Electrification optional.
 Mesa de apoyo conectora a 90° tapizada con tapa de melamina. Electrificación opcional.
 Table basse rembourrée à connecteur 90° avec plateau en mélamine. Electrification en option.

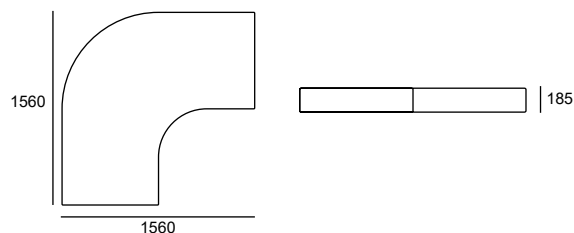

CONFIGURATIONS

CONFIGURAÇÕES / CONFIGURACIONES / CONFIGURATIONS

